

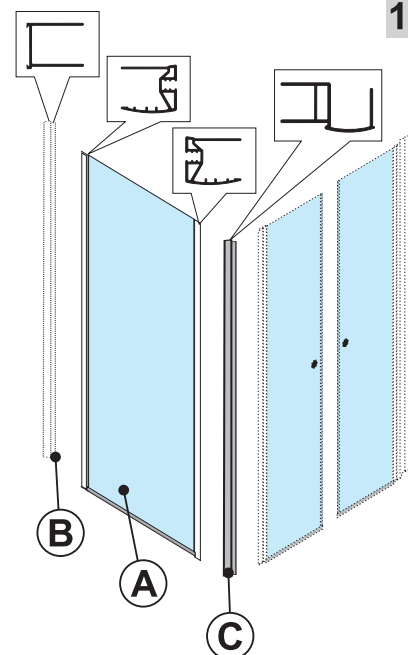

SH PS

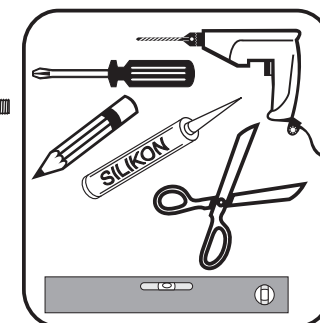
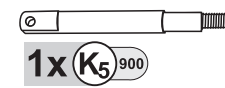
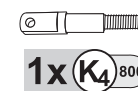
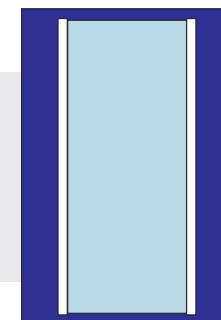
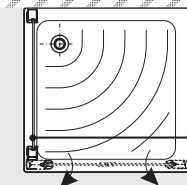

d	ø8 mm	1x
e	3,9x32 A2 (DIN 7981)	3x
f	3,9x9,5 A2 (DIN 7981)	3x
g	ø8 x 7,4 mm	3x
h	3,5x32	1x
i	ø12,5 mm	3x
j ₁	M5x12	2x
j ₂	M5x12	1x
L ₁	0,9 m	0,9 m

1a

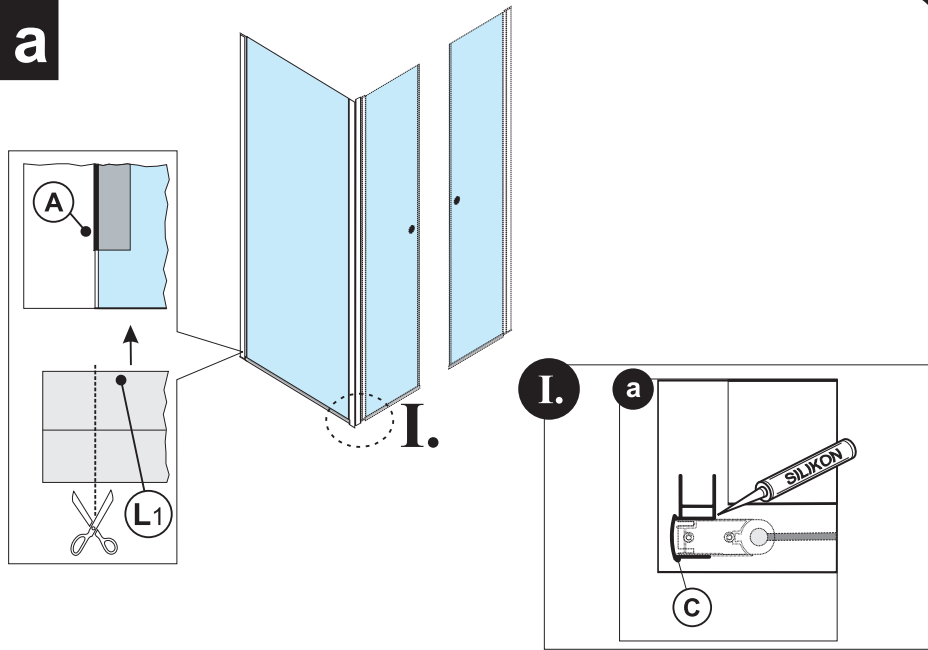

1b

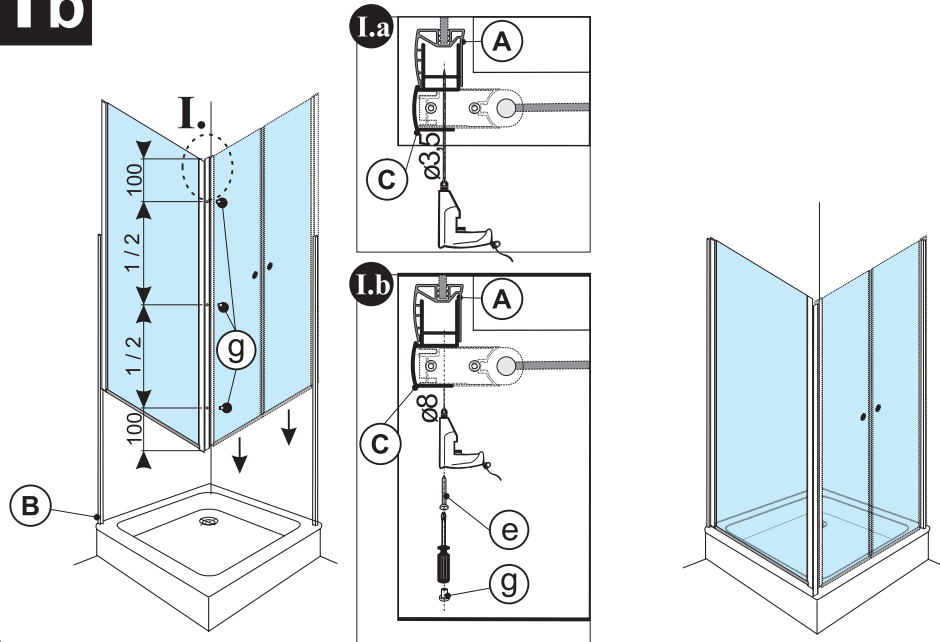

6

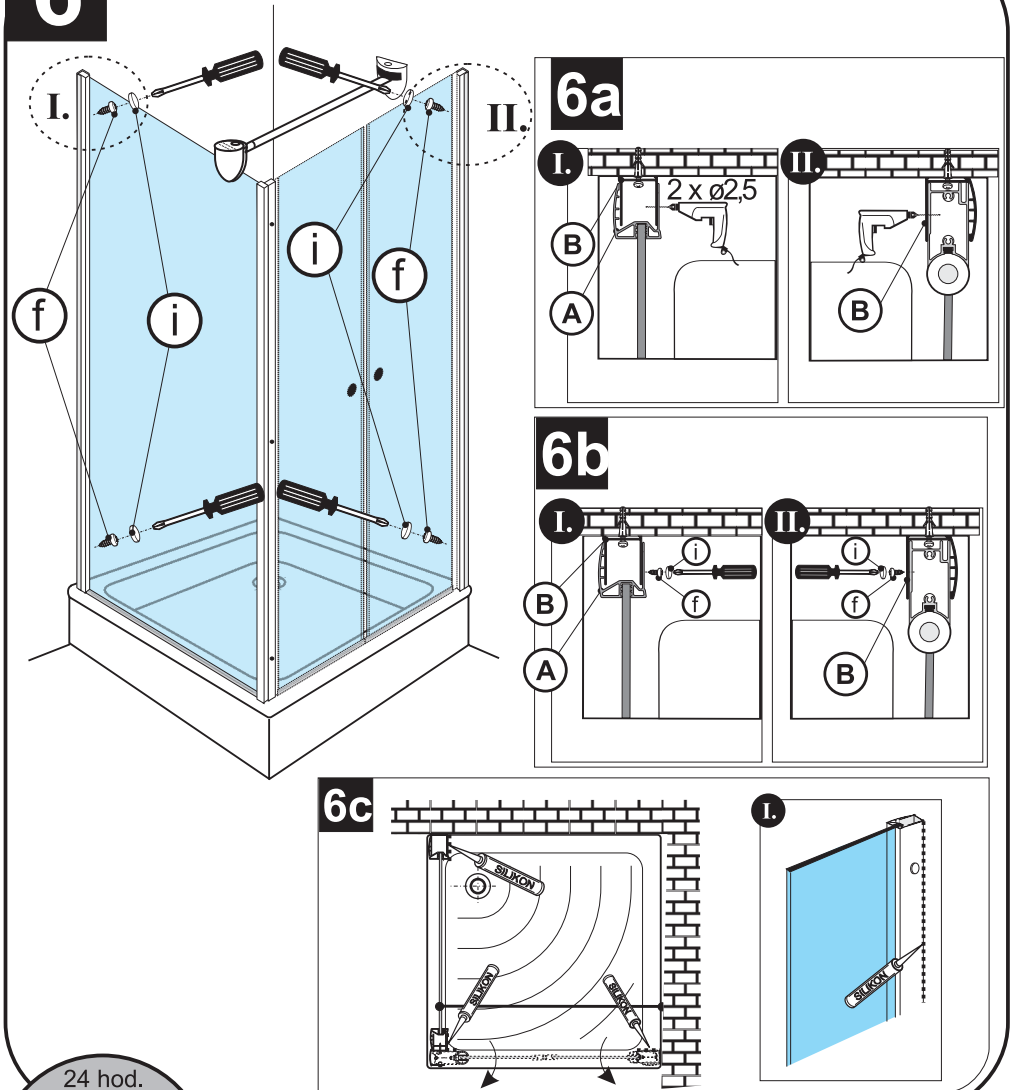

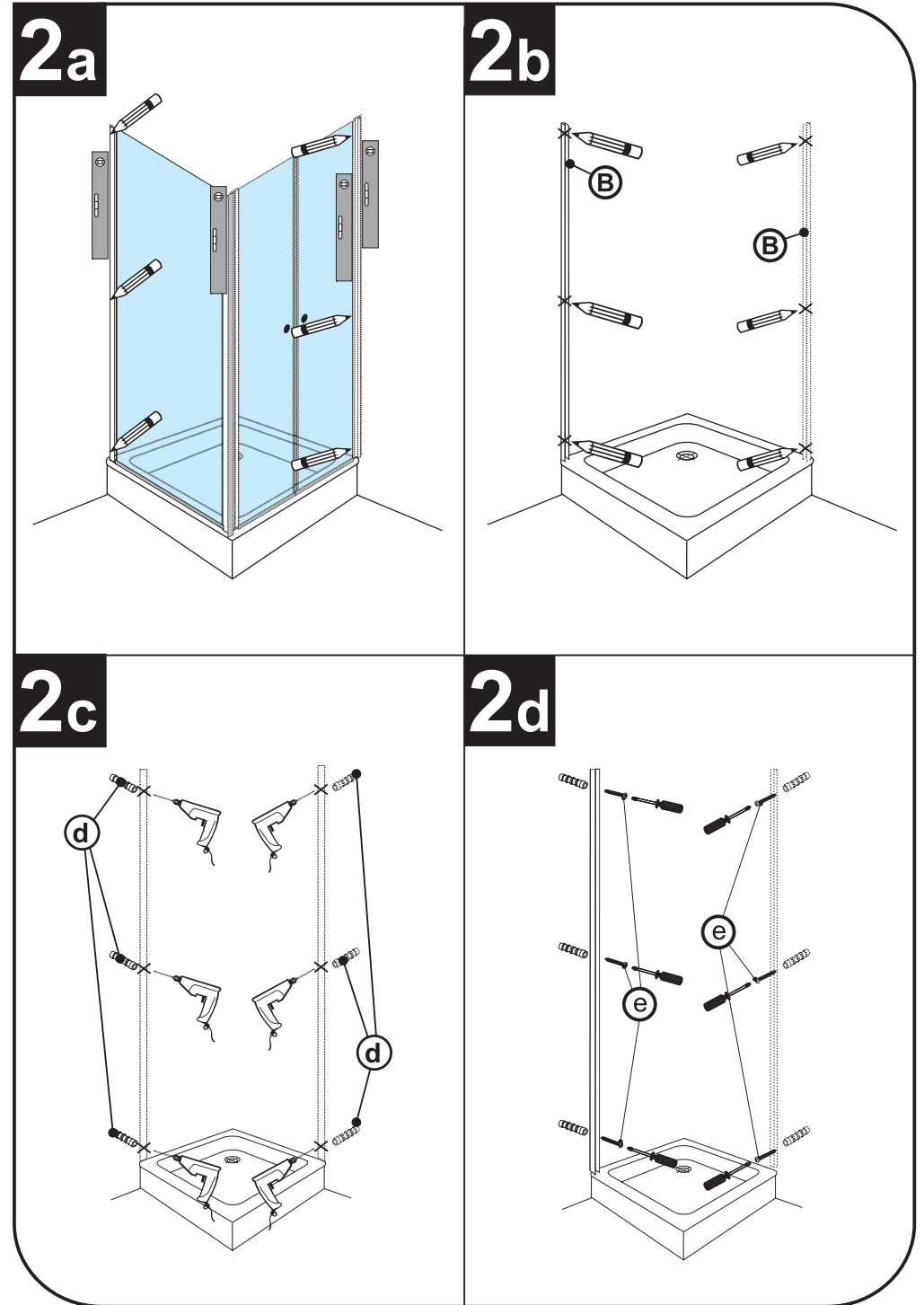
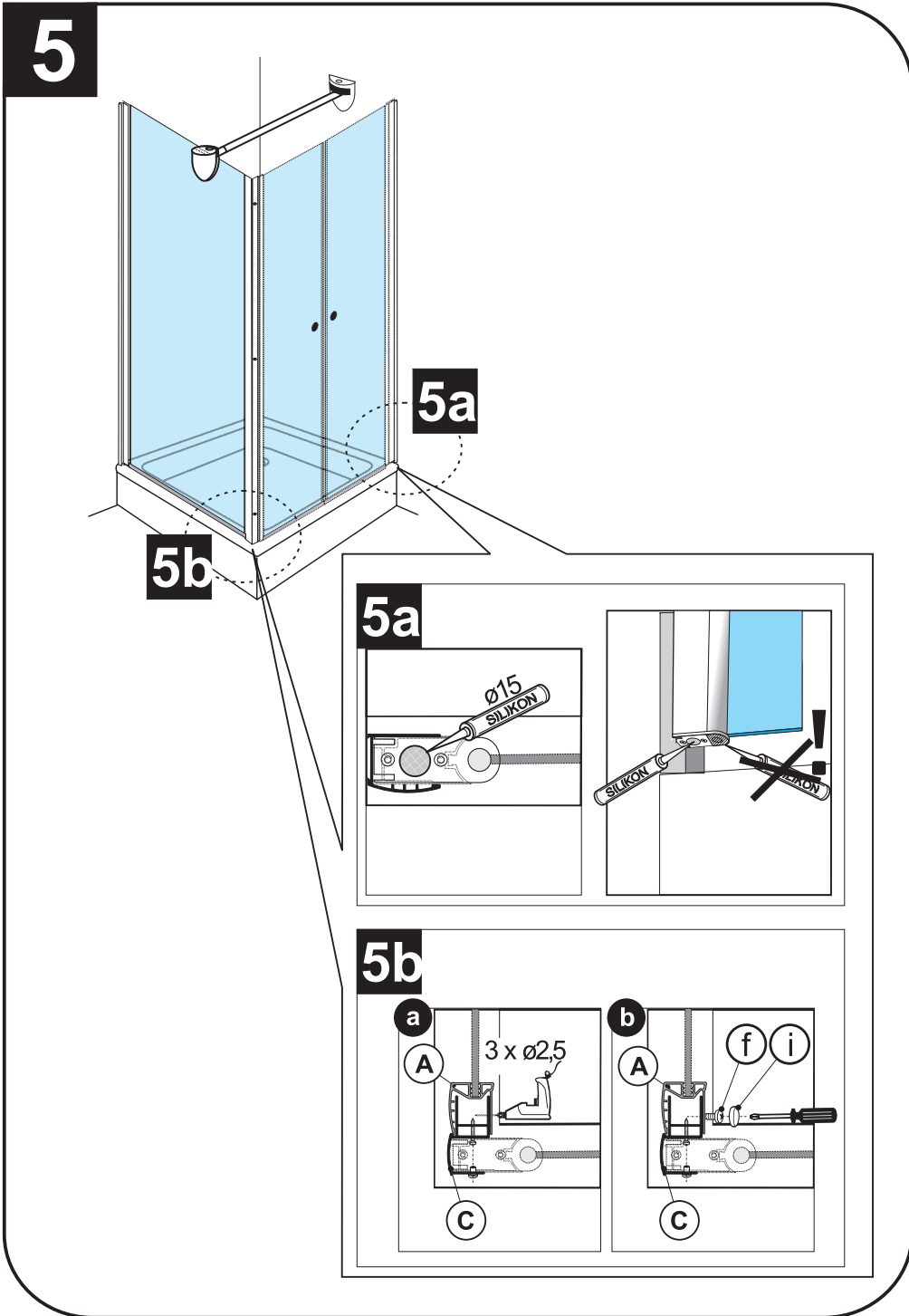

3

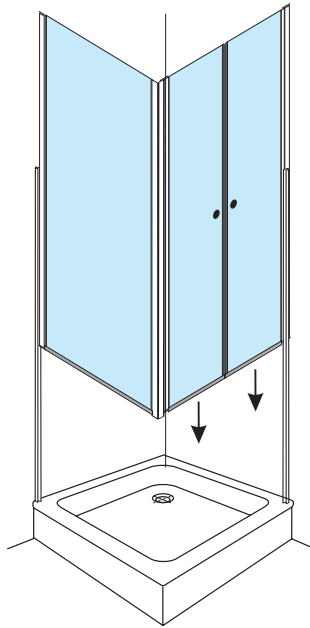

4

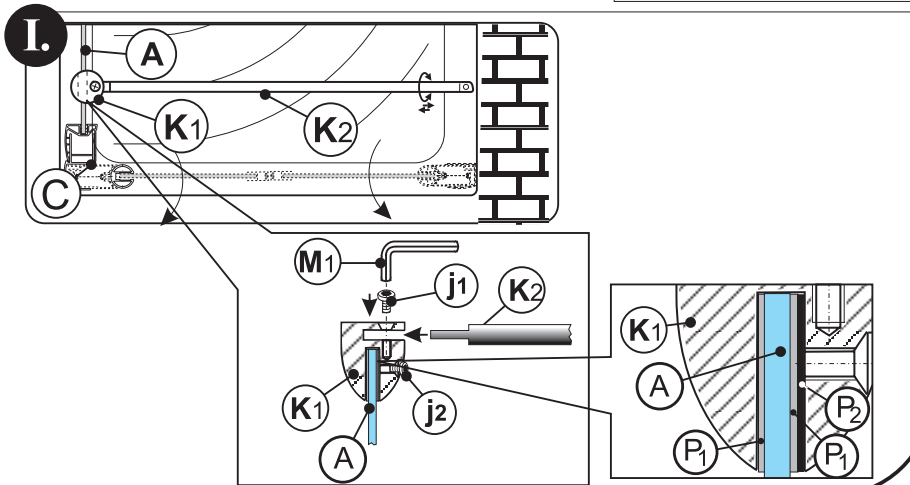
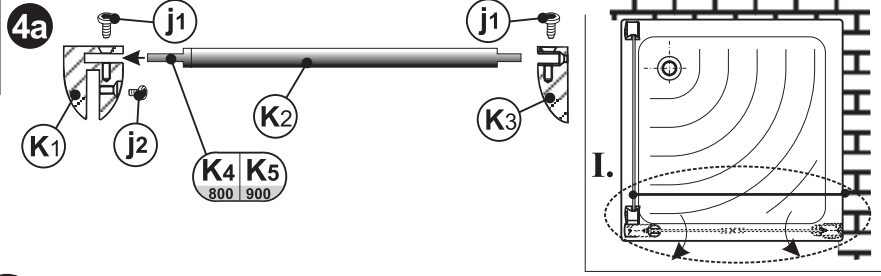

4b

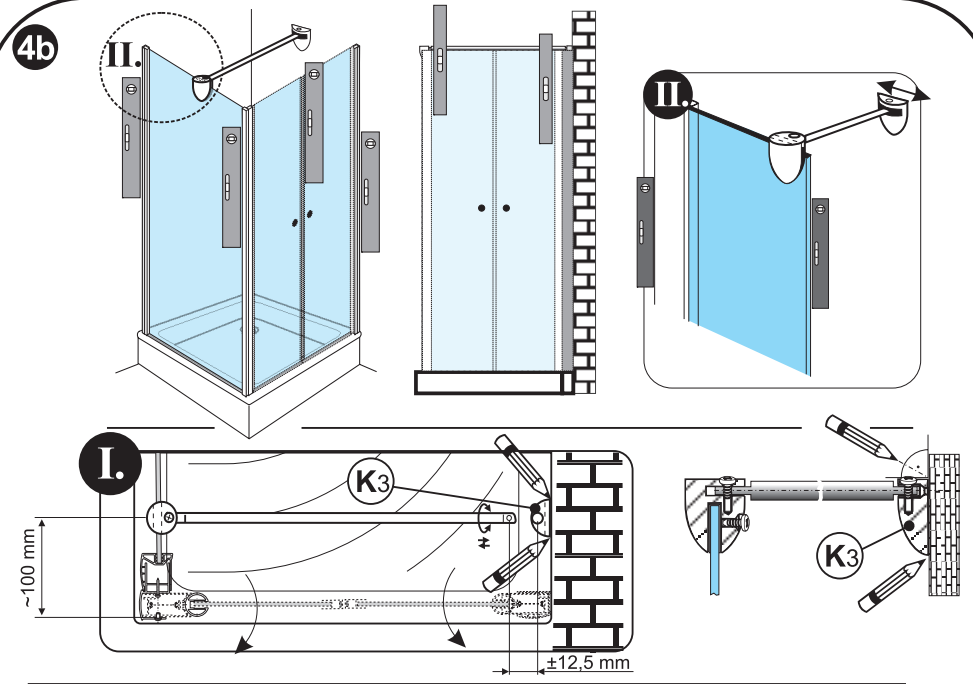

4c

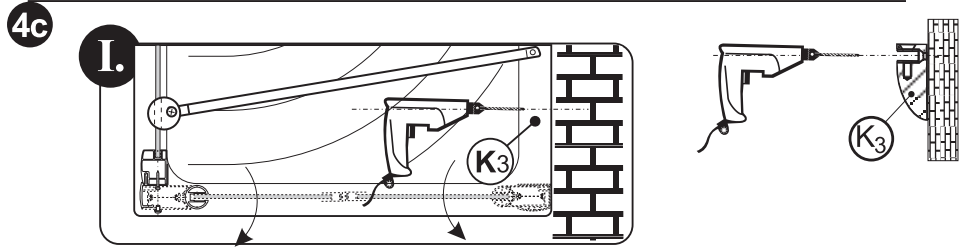

4d

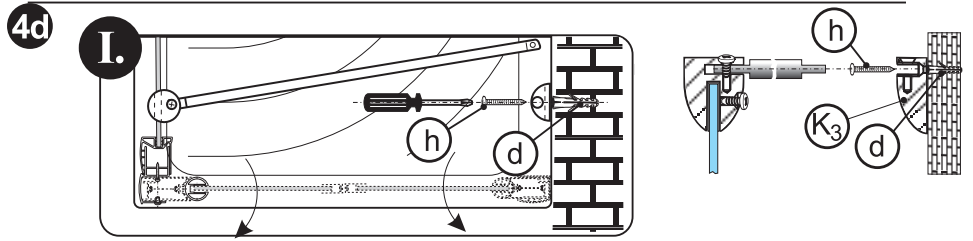

4e

